



SAN FRANCISCO PLANNING DEPARTMENT

Letter of Determination

September 13, 2016

Douglas Shortes
Matinkovic Milford Architects
101 Montgomery Street, Suite 650
San Francisco, CA 94104

| | |
|------------------------------|---|
| Site Address: | 1800 Filbert Street |
| Assessor's Block/Lot: | 0519/053 |
| Zoning District: | RH-2 (Residential, House – Two-Family) |
| Staff Contact: | Wayne Farrens, (415) 575 – 9172 or wayne.farrens@sfgov.org |
| Record Number: | 2016-009335ZAD |

1650 Mission St.
Suite 400
San Francisco,
CA 94103-2479

Reception:
415.558.6378

Fax:
415.558.6409

Planning
Information:
415.558.6377

Dear Mr. Shortes:

This letter is in response to your request for a Letter of Determination regarding the property at 1800 Filbert Street. This parcel is located in the RH-2 (Residential, House – Two-Family) Zoning District and 40-X Height and Bulk District. The request is for confirmation that “Medical Service,” as defined in Planning Code Section 790.114, is a permitted use in the existing ground floor commercial space of the subject building.

Planning Code Section 186 allows for indefinite continuance of limited commercial nonconforming uses within the RH-2 Zoning District. However, such nonconforming uses are further limited by Planning Code Section 183, which identifies a nonconforming use as abandoned if it has been discontinued for three or more years. An abandoned nonconforming use loses its nonconforming status and any subsequent uses of the subject property must conform to all applicable provisions of the Planning Code.

Planning Department records indicate that the last known legal use of the subject tenant space was a grocery store in 1985. It is unclear if and how the subject tenant space has been used since that time, but photos of the subject property taken in 2008 indicate that the grocery store use had already been discontinued at that time. Without any records documenting Planning Department approval of any subsequent commercial uses, any such uses are presumed to be illegal. Therefore, regardless of whether any commercial tenant has been present during the three-year time limit, the nonconforming use is determined to have been abandoned. However, per Planning Code Section 186(f), an abandoned nonconforming use may be reactivated with Conditional Use authorization.

In addition to the standard Conditional Use findings required by Planning Code Section 303, the Commission must also find that:

1. The subject space is located on or below the ground floor and was in commercial or industrial use prior to January 1, 1960; and
2. The proposed commercial use meets all applicable requirements of the Planning Code.

Upon approval of a Conditional Use authorization to reactivate the nonconforming commercial use of the subject property, permitted uses would be limited to those that are permitted in all of the following: 1) the NC-1 (Neighborhood Commercial Cluster); 2) any Individual Area Neighborhood Commercial District within ¼ mile of the subject property; and 3) any Restricted Use Subdistrict within ¼ mile of the subject property.

Medical Service, as defined in Planning Code Section 790.114, is a permitted use on the ground floor in both the NC-1 and the Union Street NCD Zoning Districts. The subject property is not located within ¼ mile of any other Individual Area Neighborhood Commercial District or Restricted Use Subdistrict; therefore, Medical Service would be a permitted use on the ground floor of the subject property upon reactivation of the nonconforming commercial use.

The change of use will also be subject to Planning Code Section 311 neighborhood notification. A Building Permit application for the change of use should be submitted in tandem with the Conditional Use authorization application.

Please note that a Letter of Determination is a determination regarding the classification of uses and interpretation and applicability of the provisions of the Planning Code. This Letter of Determination is not a permit to commence any work or change occupancy. Permits from appropriate Departments must be secured before work is started or occupancy is changed.

APPEAL: If you believe this determination represents an error in interpretation of the Planning Code or abuse in discretion by the Zoning Administrator, an appeal may be filed with the Board of Appeals within 15 days of the date of this letter. For information regarding the appeals process, please contact the Board of Appeals located at 1650 Mission Street, Room 304, San Francisco, or call (415) 575-6880.

Sincerely,

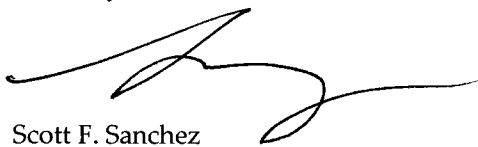

Scott F. Sanchez
Zoning Administrator

cc: William Tookoian, Property Owner
Neighborhood Groups
Wayne Farrrens, Planner

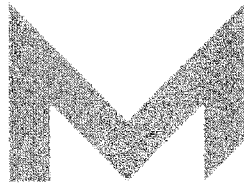

MARTINKOVIC MILFORD
ARCHITECTS

R # 2016 - 009335 ZAD
CK # 8271 \$645 -
D. LINDSAY (NW)

June 27, 2016

Scott Sanchez, Zoning Administrator
San Francisco Planning Department
1650 Mission Street, Suite 400
San Francisco, CA 94103

RE: Request for a Letter of Determination for Use Clarification.
Location: 1800 Filbert Street, San Francisco, CA 94123

Project Data

Site Address: 1800 Filbert Street
APN: 0519-053
Lot Area: Approx. 2331 sf
Ground Floor Building Area: Approx. 2042 sf
Total Building Area: Approx. 4119 sf
Stories: 2 + basement
Current Use: Commercial Office (ground level) / Residential (2nd level)
Proposed Use: Medical Service (ground level) / Residential (2nd level)

Request Summary

This letter is in request for approval and confirmation of the use in the ground floor of the building at 1800 Filbert Street. 1800 Filbert Street is an existing ground floor commercial space. The floor above is residential use and uses the address 1804 Filbert Street.

The proposed new use is "Medical Service" as defined by Section 790.114. The proposed tenant is One Medical Group and would be a 2000 square foot outpatient health clinic consistent with all requirements of section 790.114, Medical Service use.

- Our research indicates the existing use of the site is a legal continuing nonconforming use.
- Our research indicates that continuation of commercial use for the proposed new use as "Medical Service" conforms to applicable codes.
- We request a confirmation that a proposed use as Medical Service will be acceptable and approved.

Initial Research

I spoke with planning staff Monica Huggins on May 19, 2016. Monica confirmed the zoning of the property as RH-2. She indicated that I should pull the most current

CELEBRATING **15 YEARS**

101 Montgomery Street, Suite 650, San Francisco, CA 94104 MartinkovicMilford.com



approved permit from the Records Department in order to verify the current legal use. Monica indicated that if the current legal use of the space is commercial it should be allowed to continue based on *Section 209.1, Table 209.1 "Zoning Control Table for RH Districts"*. This table states that *"Continuing nonconforming uses are permitted, subject to the requirements of Section 186"*. (See Article 209.1 attached with relevant sections highlighted).

Monica further indicated on the call that if the existing use is found to be commercial, and if confirmation of continuing that use is needed, confirmation can be obtained by requesting a Letter of Determination from the Zoning Administrator. This letter is for that purpose.

Existing Use Status

Permit history was researched at the DBI records department and the most recent approved permit for the property was found to be Permit # 2006-07-18-6935 (See Attached Exhibit A). The approved use is indicated as Residential / Office Commercial. Occupancy Class is B / R-3. The permit scope is for a voluntary seismic strengthening.

The building owner has verified that the upper floor of the building is Residential use and the existing ground level space has been commercial office space continuously since this permit was approved.

Rationale for Approval

The site conforms to all requirements of Section 186 and all applicable requirements referenced therein. The following is a detailed description of each requirement and compliance:

Code Section/Requirement

Compliance

Section 209.1, Table 209.1 Zoning Control Table for RH Districts

| | |
|---|---|
| Table 209.1 states that "Continuing nonconforming uses are permitted, subject to the requirements of Section 186. | The site is a continuing non-conforming use as evidenced by the most recent approved permit indicating the approved use as commercial office space. See section above and attached permit record. |
|---|---|

Section 186. Exemption of Limited Commercial and Industrial Nonconforming Uses in RH, RM, RTO, and RED Districts

This section states that nonconforming uses listed in subsection (a) are exempt from the termination provisions of Section 185, provided such uses comply with all of the conditions specified in Subsection (b).

(a) Exemption from Termination Provisions. The following nonconforming uses in R Districts shall be exempt from the termination provisions of Section 185, provided such uses comply with all the conditions specified in Subsection (b) below:

| | |
|--|---|
| <i>(2) Any nonconforming use in an RH or RM District which is located within ¼ mile from any Individual Area Neighborhood Commercial District or restricted use subdistrict and which complies with the most</i> | The site is within ¼ mile of the Union Street Neighborhood Commercial District. The site complies with the most restrictive use limitations specified for |
|--|---|



| | |
|---|--|
| <p><i>restrictive use limitations specified for the first story and below of:</i></p> <p><i>(B) Any Individual Area Neighborhood Commercial District within ¼ mile of the use, as set forth in Sections 714.10 through 729.95 of this Code;</i></p> | <p>the first story and below of the Union Street Neighborhood Commercial District. See below.</p> |
| <p><i>(b) Conditions on Limited Nonconforming Uses. The limited nonconforming uses described above shall meet the following conditions:</i></p> | |
| <p><i>(1) The building shall be maintained in a sound and attractive condition, consistent with the general appearance of the neighborhood;</i></p> | <p>The building is currently maintained in sound and attractive condition and will be further enhanced upon renovation for new tenancy.</p> |
| <p><i>(2) Any signs on the property shall be made to comply with the requirements of Article 6 of this Code applying to nonconforming uses;</i></p> | <p>All new signage will comply with Article 6 and will be approved with applicable permits prior to installation.</p> |
| <p><i>(3) The hours during which the use is open to the public shall be limited to the period between 6:00 a.m. and 10:00 p.m.;</i></p> | <p>Intended hours of operation are no earlier/later than 8:00am to 6:00pm.</p> |
| <p><i>(4) Public sidewalk space may be occupied in connection with the use provided that it is only occupied with tables and chairs as permitted by this Municipal Code;</i></p> | <p>Proposed tenancy will be within the interior of the building. Exterior occupancy is not expected or intended.</p> |
| <p><i>(5) Truck loading shall be limited in such a way as to avoid undue interference with sidewalks, or with crosswalks, bus stops, hydrants and other public features;</i></p> | <p>Truck loading is not required for this tenancy.</p> |
| <p><i>(6) Noise, odors and other nuisance factors shall be adequately controlled; and</i></p> | <p>Noise, odors, and nuisance factors will not be generated by this tenancy.</p> |
| <p><i>(7) All other applicable provisions of this Code shall be complied with.</i></p> | <p>Permits for the renovation will be secured prior to construction of the interior renovation and all applicable provisions of the code shall be complied with.</p> |
| <p><i>(c) Formula Retail Uses. All uses meeting the definition of "formula retail" use per Section 303.1 shall not be permitted except by conditional use authorization under the procedures of Section 303 of this Code</i></p> | <p>Proposed use is not a Formula Retail use as defined by Section 303.1. This was further confirmed by in my discussion with Monica Huggins.</p> |
| <p><i>(d) Street Frontage. In addition to the requirements of Section 144 of this Code, the requirements of Section 145.1(c)(6) and (7) shall apply</i></p> | <p>Section 144 compliance: there are no garage entrances in this building.</p> <p>Section 145 compliance: The Filbert Street and Octavia Street frontage is approximately 61.2% transparent. Transparency will be maintained in the proposed design. No decorative grilles or grates are to be proposed in the design.</p> |

| | |
|--|--|
| <i>(e) Awnings. Awnings are permitted, subject to the standards in Section 136.1(a) of this Code. Canopies and marquees are not permitted.</i> | Existing awning shall remain and is compliant with all provisions of Section 136.1(a). |
|--|--|

Section "725 Union Street Neighborhood Commercial District:

Section 725 defines the following use requirements applicable to this site per Section 186(a)(2)(B) and proposed use. The existing nonconforming use and proposed use conforms to these requirements:

| <i>Table 725 Zoning control Table Requirements:</i> | |
|--|--|
| <i>725.20 Floor Area Ratio: 3.0 to 1.</i> | Floor area ratio is approximately 1.80 to 1. (4,119sf/2331sf) |
| <i>725.21 Use Size [Non-Residential]: Permitted up to 2,499 sq.ft.</i> | The ground floor commercial building area is approximately 2042 sf. |
| <i>725.22 Off-street parking, Commercial/Intuitional: Generally none required if occupied floor area is less than 5000 sf.</i> | No off street parking provided. |
| <i>725.23 Off-street freight loading: Generally non required if gross floor area is less than 10,000 sf.</i> | No off street freight loading provided |
| <i>725.24 Outdoor Activity Area: Permitted if located in front</i> | None provided |
| <i>725.26 Walk up facility: permitted</i> | Not a walk up facility |
| <i>725.27 Hours of operation: Permitted 6am to 2am</i> | Proposed hours of operation are no earlier/later than 8am to 6pm. |
| <i>725.31 Business Sign: Permitted.</i> | Business signage shall comply with all applicable parts of the code and shall be approved by applicable permits prior to installation. |
| <i>725.32 Other signage: Permitted</i> | Other, non business, signage is not anticipated for this project. |
| <i>725.51 Medical Service: Permitted at 1st story.</i> | Proposed use is permitted at 1 st story. |

Summary

- Our research indicates the existing use of the site is a legal continuing nonconforming use.
- Our research indicates that continuation of commercial use for the proposed new use as "Medical Service" conforms to applicable codes.
- We request a confirmation that a proposed use as Medical Service will be acceptable and approved.

Attachments

Exhibit A

Site location map with ¼ mile radius.

Exhibit B



Permit # 2006-07-18-6935, approved July 18, 2006.

Exhibit C

Relevant Code Sections:

- *Section 209.1. RH (Residential, House) Districts*
- *Section 186. Exemption of Limited Commercial and Industrial Nonconforming Uses in RH, RM, RTO, and RED Districts*
- *Section 725. Union Street Neighborhood Commercial District*

Exhibit D

Property Report for 1800 Filbert from SF Planning Department Website

Exhibit E

Existing building photograph.

Exhibit F

Building ground level elevations showing percentage of transparency.

Thank you for your attention to this request. If there are any questions my contact information is below.

Sincerely,



Douglas Shortes, Architect
Martinkovic Milford Architects

Martinkovic Milford Architects
101 Montgomery Street, Suite 650
San Francisco, CA 94104
(415) 346-9990
douglas@martinkovicmilford.com

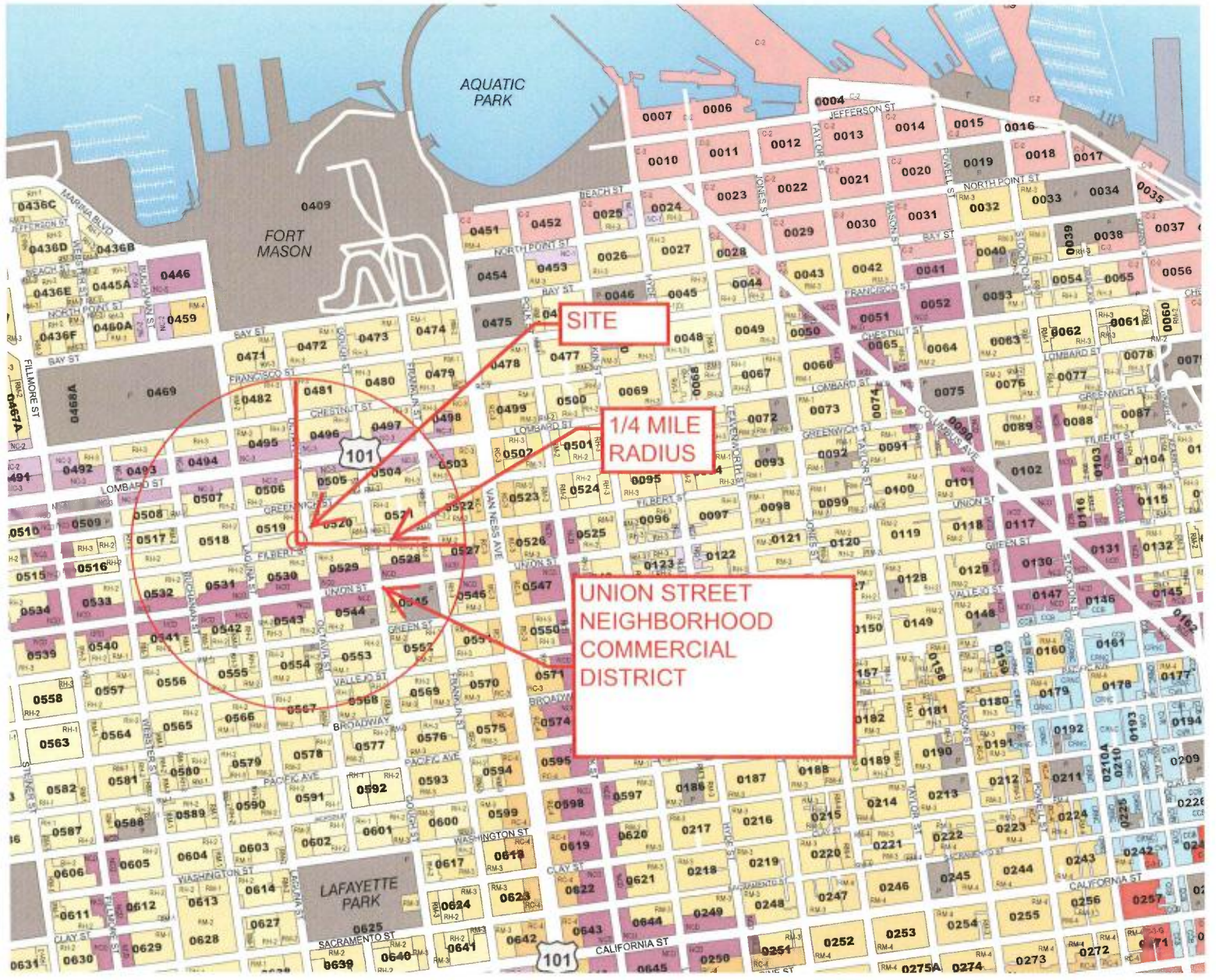

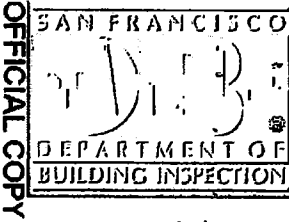

APPROVED

Dept. of Building Insp.

JUL 18 2006

ACTING DIRECTOR

DEPT. OF BUILDING INSPECTION

EXHIBIT B

BLDG. FORM

18

006107101693

APPLICATION NUMBER

OSHA APPROVAL RECORD

APPROVED FOR INSTALLATION

Per. shown by plans and in accordance with the Building Code and the Department of Building Inspection... (vertical text)

NO VIOL.

APPLICATION FOR BUILDING PERMIT ADDITIONS, ALTERATIONS OR REPAIRS

CITY AND COUNTY OF SAN FRANCISCO DEPARTMENT OF BUILDING INSPECTION

FORM 3 OTHER AGENCIES REVIEW REQUIRED

APPLICATION IS HEREBY MADE TO THE DEPARTMENT OF BUILDING INSPECTION OF SAN FRANCISCO FOR PERMISSION TO BUILD IN ACCORDANCE WITH THE PLANS AND SPECIFICATIONS SUBMITTED HERewith AND ACCORDING TO THE DESCRIPTION AND FOR THE PURPOSE HEREINAFTER SET FORTH.

FORM 8 OVER-THE-COUNTER ISSUANCE 2 + 2 copies - NUMBER OF PLAN SETS 7/18/06

DATE FILED 7/18/2006, PERMIT NO. 1092573, ISSUED 7/18/06, STREET ADDRESS 1800 FILBERT ST, ESTIMATED COST \$25,000, REVISED COST \$27,000, DATE 7/18/06

INFORMATION TO BE FURNISHED BY ALL APPLICANTS

LEGAL DESCRIPTION OF EXISTING BUILDING, DESCRIPTION OF BUILDING AFTER PROPOSED ALTERATION, ADDITIONAL INFORMATION, IMPORTANT NOTICES, NOTICE TO APPLICANT

IMPORTANT NOTICES: No change shall be made in the character of the occupancy or use without first obtaining a Building Permit... (vertical text)

NOTICE TO APPLICANT: HOLD HARMLESS CLAUSE. The permittee(s) by acceptance of the permit, agree(s) to indemnify and hold harmless the City and County of San Francisco... (vertical text)

APPLICANT'S CERTIFICATION: I HEREBY CERTIFY AND AGREE THAT IF A PERMIT IS ISSUED FOR THE CONSTRUCTION DESCRIBED IN THIS APPLICATION, ALL THE PROVISIONS OF THE PERMIT AND ALL LAWS AND ORDINANCES THERE TO WILL BE COMPLIED WITH.

Signature of Applicant or Agent, Date 6.23.06

OFFICIAL COPY

SAN FRANCISCO
DEPARTMENT OF BUILDING INSPECTION

MAINTAIN FIRE PROTECTION SYSTEMS PER CHAPTER 9, SFBC
STAIRWELL AND CEILING FINISH PER CHAPTER 8, SFBC
FIRE-RESISTIVE RELATIONSHIP, AND REQUIREMENTS PER CHAPTER 6 AND TABLE NO. 6A, SFBC

Submit the final building inspection at the start of work call 311-3333, for plumbing inspection scheduling call 311-3333, for electrical inspection scheduling call 311-3333. This application is approved without site inspection, detailed drawings or electrical plan review and does not constitute an approval of the building. Work authorized must be done in strict accordance with all applicable codes. Any electrical or plumbing work shall require separate permits.

| | | | |
|--------------------------|---|---|--|
| <input type="checkbox"/> | APPROVED: | <i>N/A</i> | NOTIFIED MR. _____ DATE: _____ REASON: _____ |
| <input type="checkbox"/> | APPROVED: | DEPARTMENT OF CITY PLANNING By DENNIS F. DANG, DBI JUL 18 2008 | NOTIFIED MR. _____ DATE: _____ REASON: _____ |
| <input type="checkbox"/> | APPROVED: | BUREAU OF FIRE PREVENTION & PUBLIC SAFETY | NOTIFIED MR. _____ DATE: _____ REASON: _____ |
| <input type="checkbox"/> | APPROVED: | MECHANICAL ENGINEER, DEPT OF BLDG. INSPECTION | NOTIFIED MR. _____ DATE: _____ REASON: _____ |
| <input type="checkbox"/> | APPROVED: <i>Voluntary gravity & seismic strengthening only - not to any particular code level.</i> | By <i>[Signature]</i> SUSAN S. LEONG, DBI CIVIL ENGINEER, DEPT. OF BLDG INSPECTION JUL 18 2008 | NOTIFIED MR. _____ DATE: _____ REASON: _____ |
| <input type="checkbox"/> | APPROVED: | <i>N/A</i> | NOTIFIED MR. _____ DATE: _____ REASON: _____ |
| <input type="checkbox"/> | APPROVED: | BUREAU OF ENGINEERING By DENNIS F. DANG, DBI JUL 18 2008 | NOTIFIED MR. _____ DATE: _____ REASON: _____ |
| <input type="checkbox"/> | APPROVED: | DEPARTMENT OF PUBLIC HEALTH | NOTIFIED MR. _____ DATE: _____ REASON: _____ |
| <input type="checkbox"/> | APPROVED: | REDEVELOPMENT AGENCY | NOTIFIED MR. _____ DATE: _____ REASON: _____ |
| <input type="checkbox"/> | APPROVED: | HOUSING INSPECTION DIVISION | NOTIFIED MR. _____ DATE: _____ REASON: _____ |

HOLD SECTION - NOTE DATES AND NAMES OF ALL PERSONS NOTIFIED DURING PROCESSING

I agree to comply with all conditions or stipulations of the various bureaus or department noted on this application, and attached statements of conditions or stipulations, which are hereby made a part of this application.

Number of attachments

OWNER'S AUTHORIZED AGENT _____

San Francisco Planning Code

SEC. 209.1. RH (RESIDENTIAL, HOUSE) DISTRICTS.

These Districts are intended to recognize, protect, conserve and enhance areas characterized by dwellings in the form of houses, usually with one, two or three units with separate entrances, and limited scale in terms of building width and height. Such areas tend to have similarity of building styles and predominantly contain large units suitable for family occupancy, considerable open space, and limited nonresidential uses. The RH Districts are composed of five separate classes of districts, as follows:

RH-1(D) Districts: One-Family (Detached Dwellings). These Districts are characterized by lots of greater width and area than in other parts of the City, and by single-family houses with side yards. The structures are relatively large, but rarely exceed 35 feet in height. Ground level open space and landscaping at the front and rear are usually abundant. Much of the development has been in sizable tracts with similarities of building style and narrow streets following the contours of hills. In some cases private covenants have controlled the nature of development and helped to maintain the street areas.

RH-1 Districts: One-Family. These Districts are occupied almost entirely by single-family houses on lots 25 feet in width, without side yards. Floor sizes and building styles vary, but tend to be uniform within tracts developed in distinct time periods. Though built on separate lots, the structures have the appearance of small-scale row housing, rarely exceeding 35 feet in height. Front setbacks are common, and ground level open space is generous. In most cases the single-family character of these Districts has been maintained for a considerable time.

RH-1(S) Districts: One-Family with Minor Second Unit. These Districts are similar in character to RH-1 Districts, except that a small second dwelling unit has been installed in many structures, usually by conversion of a ground-story space formerly part of the main unit or devoted to storage. The second unit remains subordinate to the owner's unit, and may house one or two persons related to the owner or be rented to others. Despite these conversions, the structures retain the appearance of single-family dwellings.

RH-2 Districts: Two-Family. These Districts are devoted to one-family and two-family houses, with the latter commonly consisting of two large flats, one occupied by the owner and the other available for rental. Structures are finely scaled and usually do not exceed 25 feet in width or 40 feet in height. Building styles are often more varied than in single-family areas, but certain streets and tracts are quite uniform. Considerable ground-level open space is available, and it frequently is private for each unit. The Districts may have easy access to shopping facilities and transit lines. In some cases, Group Housing and institutions are found in these areas, although nonresidential uses tend to be quite limited.

RH-3 Districts: Three-Family. These Districts have many similarities to RH-2 Districts, but structures with three units are common in addition to one-family and two-family houses. The predominant form is large flats rather than apartments, with lots 25 feet wide, a fine or moderate scale and separate entrances for each unit. Building styles tend to be varied but complementary to one another. Outdoor space is available at ground level, and also on decks and balconies for individual units. Nonresidential uses are more common in these areas than in RH-2 Districts.

**Table 209.1
ZONING CONTROL TABLE FOR RH DISTRICTS**

| Zoning Category | § References | RH-1(D) | RH-1 | RH-1(S) | RH-2 | RH-3 |
|-------------------------------|--|---|---------------|---------|--|--------------------------------|
| BUILDING STANDARDS | | | | | | |
| <i>Massing and Setbacks</i> | | | | | | |
| Height and Bulk Limits | §§ 102, 105, 106, 250-252, 253, 260, 261, 270, 271. See also Height and Bulk District Maps | No portion of a Dwelling may be taller than 35 feet. Structures with uses other than Dwellings may be constructed to the prescribed height limit, which is generally 40 feet. Per § 261 the height limit may be decreased or increased based on the slope of the lot. | | | No portion of a Dwelling may be taller than 40 feet. Structures with uses other than Dwellings may be constructed to the prescribed height limit. Per § 261 the height limit may be decreased based on the slope of the lot. | Varies, but generally 40 feet. |
| Front Setback | §§ 130, 131, 132 | Required. Based on average of adjacent properties or if subject property has a Legislated Setback. When front setback is based on adjacent properties, in no case shall the required setback be greater than 15 feet. | | | | |
| Rear Yard | §§ 130, 134 | 25% of lot depth, but in no case less than 15 feet. | | | 45% of lot depth or average of adjacent neighbors. If averaged, no less than 25% or 15 feet, whichever is greater. | |
| Side Yard | §§ 130, 133 | Required for lots 28 feet and wider. Width of side setback depends on width of lot. | Not Required. | | | |
| Residential Design Guidelines | § 311 | Subject to the Residential Design Guidelines. Other design guidelines that have been approved by the Planning Commission may also apply. | | | | |

| Street Frontage and Public Realm | | | | | | |
|--|-------------|--|---|---|---|---|
| Front Setback Landscaping and Permeability Requirements | § 132 | Required. At least 50% of Front Setback shall be permeable so as to increase storm water infiltration and 20% of Front Setback shall be unpaved and devoted to plant material. | | | | |
| Streetscape and Pedestrian Improvements (Street Trees) | § 138.1 | Required. | | | | |
| Street Frontage Requirements | § 144 | § 144 applies generally. Additional requirements apply to Limited Commercial Uses, as specified in § 186. | | | | |
| Street Frontage, Parking and Loading Access Restrictions | § 155(r) | As specified in § 155(r) | | | | |
| Miscellaneous | | | | | | |
| Large Project Review | § 253 | C required for projects over 40 feet in height. | | | | |
| Planned Unit Development | § 304 | C | C | C | C | C |
| Awning | § 136.1 | P(1) | P(1) | P(1) | P(1) | P(1) |
| Canopy or Marquee | § 136.1 | NP | NP | NP | NP | NP |
| Signs | § 606 | As permitted by Section § 606 | | | | |
| RESIDENTIAL STANDARDS AND USES | | | | | | |
| Development Standards | | | | | | |
| Usable Open Space [Per Dwelling Unit] | §§ 135, 136 | At least 300 square feet if private, and 400 square feet if common. | At least 300 square feet if private, and 400 square feet if common. | At least 300 square feet for the first unit and 100 for the minor second unit if private, and 400 square feet for the first unit and 133 square feet for the second unit if common. | At least 125 square feet if private, and 166 square feet if common. | At least 100 square feet if private, and 133 square feet if common. |
| Parking Requirements | §§ 151, 161 | Generally, a minimum of one space for every Dwelling Unit required. Certain exceptions permitted per § 161. | | | | |
| Residential Conversion, Demolition, or Merger | § 317 | C for Removal of one or more Residential Units or Unauthorized Units. | | | | |
| Use Characteristics | | | | | | |
| Single Room Occupancy | § 102 | P | P | P | P | P |
| Student Housing | § 102 | P | P | P | P | P |

| Residential Uses | | | | | | |
|---|------------------|---|--|--|--|--|
| Residential Density, Dwelling Units (7) | § 207 | One unit per lot. | P up to one unit per lot. C up to one unit per 3,000 square feet of lot area, with no more than three units per lot. | P up to two units per lot, if the second unit is 600 sq. ft. or less. C up to one unit per 3,000 square feet of lot area, with no more than three units per lot. | P up to two units per lot. C up to one unit per 1,500 square feet of lot area. | P up to three units per lot. C up to one unit per 1,000 square feet of lot area. |
| Senior Housing | §§ 102, 202.2(f) | P up to twice the number of dwelling units otherwise permitted as a principal use in the district and meeting all the requirements of § 202.2(f)(1). C up to twice the number of dwelling units otherwise permitted as a principal use in the district and meeting all requirements of Section § 202.2(f)(1) except for § 202.2(f)(1)(D)(iv), related to location. | | | | |
| Residential Density, Group Housing | § 208 | NP | NP | NP | C, up to one bedroom for every 415 square feet of lot area. | C, up to one bedroom for every 275 square feet of lot area. |
| Homeless Shelter | §§ 102, 208 | NP | NP | NP | C | C |
| NON-RESIDENTIAL STANDARDS AND USES | | | | | | |
| Development Standards | | | | | | |
| Floor Area Ratio | §§ 102, 123, 124 | 1.8 to 1 | 1.8 to 1 | 1.8 to 1 | 1.8 to 1 | 1.8 to 1 |
| Off-Street Parking | §§ 150, 151, 161 | Required. Number of spaces determined by use per § 151. Certain exceptions permitted per § 161. | | | | |
| Limited Commercial Uses | §§ 186, 186.3 | Continuing nonconforming uses are permitted, subject to the requirements of § 186. Limited Commercial Uses may be conditionally permitted in historic buildings subject to § 186.3. | | | | |
| Agricultural Use Category | | | | | | |
| Agricultural Uses* | §§ 102, 202.2(c) | C | C | C | C | C |
| Agriculture, Neighborhood | §§ 102, 202.2(c) | P | P | P | P | P |
| Automotive Use Category | | | | | | |
| Automotive Uses* | § 102 | NP | NP | NP | NP | NP |

| | | | | | | |
|--|-------|-------|-------|-------|-------|-------|
| Parking Garage, Private | § 102 | C | C | C | C | C |
| Parking Lot, Private | § 102 | C | C | C | C | C |
| Entertainment, Arts and Recreation Use Category | | | | | | |
| Entertainment, Arts and Recreation Uses* | § 102 | NP | NP | NP | NP | NP |
| Open Recreation Area | § 102 | C | C | C | C | C |
| Passive Outdoor Recreation | § 102 | P | P | P | P | P |
| Industrial Use Category | | | | | | |
| Industrial Uses* | § 102 | NP | NP | NP | NP | NP |
| Institutional Use Category | | | | | | |
| Institutional Uses* | § 102 | NP | NP | NP | NP | NP |
| Child Care Facility | § 102 | P (2) | P (2) | P (2) | P (2) | P (2) |
| Community Facility | § 102 | C | C | C | C | C |
| Hospital | § 102 | C | C | C | C | C |
| Post-Secondary Ed. Institution | § 102 | C | C | C | C | C |
| Public Facilities | § 102 | P | P | P | P | P |
| Religious Institution | § 102 | C | C | C | C | C |
| Residential Care Facility | § 102 | P (3) | P (3) | P (3) | P (3) | P (3) |
| School | § 102 | C | C | C | C | C |
| Sales and Service Category | | | | | | |
| Retail Sales and Service Uses* | § 102 | NP | NP | NP | NP | NP |
| Hotel | § 102 | NP | NP | NP | C (4) | C (4) |
| Mobile Food Facility | § 102 | P (5) | P (5) | P (5) | P (5) | P (5) |
| Mortuary | § 102 | C (6) | C (6) | C (6) | C (6) | C (6) |
| Non-Retail Sales and Service* | § 102 | NP | NP | NP | NP | NP |
| Utility and Infrastructure Use Category | | | | | | |
| Utility and Infrastructure* | § 102 | NP | NP | NP | NP | NP |
| Internet Service Exchange | § 102 | C | C | C | C | C |
| Utility Installation | § 102 | C | C | C | C | C |
| Wireless Telecommunication Services Facility | § 102 | C | C | C | C | C |

* Not listed below.

(1) P for Limited Commercial Uses per § 136.1(a) only; otherwise NP.

- (2) C required for 15 or more children.
- (3) C required for 7 or more persons.
- (4) C for 5 or fewer guest rooms or suites of rooms; NP for 6 or more guest rooms.
- (5) Use must be located on a parcel that contains a Hospital or a Post-Secondary Educational Institution, additional operating restrictions apply.
- (6) Must be located on a landmark site, and where the site is within a Height and Bulk District of 40 feet or less, and where a columbarium use has lawfully and continuously operated since the time of designation.
- (7) Construction of Accessory Dwelling Units may be permitted pursuant to Section 207(c)(4).

(Added as Sec. 206.1 by Ord. 443-78, App. 10/6/78; redesignated and amended by Ord. [22-15](#), File No. 141253, App. 2/20/2015, Eff. 3/22/2015; amended by Ord. [161-15](#), File No. 150804, App. 9/18/2015, Eff. 10/18/2015; Ord. [162-15](#), File No. 150805, App. 9/18/2015, Eff. 10/18/2015; Ord. [188-15](#), File No. 150871, App. 11/4/2015, Eff. 12/4/2015; Ord. [33-16](#), File No. 160115, App. 3/11/2016, Eff. 4/10/2016)

(Former Sec. 209.1 added by Ord. 443-78, App. 10/6/78; amended by Ord. 72-08, File No. 071157, App. 4/3/2008; Ord. 298-08, File No. 081153, App. 12/19/2008; Ord. 130-10, File No. 090906, App. 6/24/2010; repealed by Ord. [22-15](#), File No. 141253, App. 2/20/2015, Eff. 3/22/2015)

AMENDMENT HISTORY

Former Sec. 206.1 redesignated as Sec. 209.1; Table 209.1 added; Ord. [22-15](#), Eff. 3/22/2015. Note (7) added; Ords. [161-15](#) and [162-15](#), Eff. 10/18/2015. Table 209.1 amended; Ord. [188-15](#), Eff. 12/4/2015. Table 209.1 amended; Ord. [33-16](#), Eff. 4/10/2016.

SEC. 186. EXEMPTION OF LIMITED COMMERCIAL AND INDUSTRIAL NONCONFORMING USES IN RH, RM, RTO, AND RED DISTRICTS.

The purpose of this Section is to provide for the further continuance in RH, RM, RTO, and RED Districts of nonconforming uses of a limited commercial and industrial character, as herein described, which are beneficial to, or can be accommodated within, the residential areas in which they are located. It is hereby found and declared that, despite the general incompatibility of nonconforming uses with the purposes of this Code, and with other nearby uses, these limited commercial uses may be tolerated in residential areas, and tend to provide convenience goods and services on a retail basis to meet the frequent and recurring needs of neighborhood residents within a short distance of their homes or, within the South of Market RED Districts, tend to provide jobs and continuation of small scale service and light industrial activities. These uses tend to be small in scale, to serve primarily a walk-in trade, and cause a minimum of interference with nearby streets and properties. Accordingly, this Section recognizes the public advantages of these uses and establishes conditions for their continued operation.

(a) **Exemption from Termination Provisions.** The following nonconforming uses in R Districts shall be exempt from the termination provisions of Section 185, provided such uses comply with all the conditions specified in Subsection (b) below:

(1) Any nonconforming use at any story in an RTO, RH or RM District which is located more than ¼ mile from the nearest Individual Area Neighborhood Commercial District or Restricted Use Subdistrict described in Article 7 of this Code, and which complies with the use limitations specified for the first story and below of an NC-1 District, as set forth in Sections 710.10 through 710.95 of this Code.

(2) Any nonconforming use in an RH or RM District which is located within ¼ mile from any Individual Area Neighborhood Commercial District or restricted use subdistrict and which complies with the most restrictive use limitations specified for the first story and below of:

(A) NC-1 District, as set forth in Sections 710.10 through 710.95 of this Code; and

(B) Any Individual Area Neighborhood Commercial District within ¼ mile of the use, as set forth in Sections 714.10 through 729.95 of this Code;

(C) Any Restricted Use Subdistrict within ¼ mile of the use, as set forth in Sections 781 through 781.7 of this Code.

(3) In the RED Districts, any nonconforming use which is a personal service use falling within zoning category 816.31; home and business service use falling within zoning categories 816.42 through 816.47; live/work unit falling within zoning category 816.55; wholesale sales, storage or light manufacturing uses falling within zoning categories 816.64 through 816.67.

(b) **Conditions on Limited Nonconforming Uses.** The limited nonconforming uses described above shall meet the following conditions:

(1) The building shall be maintained in a sound and attractive condition, consistent with the general appearance of the neighborhood;

(2) Any signs on the property shall be made to comply with the requirements of Article 6 of this Code applying to nonconforming uses;

(3) The hours during which the use is open to the public shall be limited to the period between 6:00 a.m. and 10:00 p.m.;

(4) Public sidewalk space may be occupied in connection with the use provided that it is only occupied with tables and chairs as permitted by this Municipal Code;

(5) Truck loading shall be limited in such a way as to avoid undue interference with sidewalks, or with crosswalks, bus stops, hydrants and other public features;

(6) Noise, odors and other nuisance factors shall be adequately controlled; and

(7) All other applicable provisions of this Code shall be complied with.

(c) **Formula Retail Uses.** All uses meeting the definition of "formula retail" use per Section 303.1 shall not be permitted except by conditional use authorization under the procedures of Section 303 of this Code.

(d) **Street Frontage.** In addition to the requirements of Section 144 of this Code, the requirements of Section 145.1(c)(6) and (7) shall apply.

(e) **Awnings.** Awnings are permitted, subject to the standards in Section 136.1(a) of this Code. Canopies and marquees are not permitted.

(f) **Termination.** Any use affected by this Section which does not comply with all of the conditions herein specified shall be subject to termination in accordance with Section 185 at the expiration of the period specified in that Section, but shall be qualified for consideration as a conditional use under Section 185(e). Any such use which is in compliance with such conditions at the expiration of such period but fails to comply therewith at any later date shall be subject to termination when it ceases to comply with any of such conditions.

(g) **Reactivation.** Limited commercial uses in RH, RM, RTO, and RED Districts that have been discontinued or abandoned, as defined in Section 183, may be reactivated with conditional use authorization under Section 303. In approving such a use and in addition to the findings required by Section 303, the Planning Commission shall find that:

(1) the subject space is located on or below the ground floor and was in commercial or industrial use prior to January 1, 1960; and

(2) the proposed commercial use meets all the requirements of this section and other applicable sections of this Code.

(h) **Other Applicable Provisions.** The provisions for nonconforming uses contained in Sections 180 through 183 shall continue to apply to all uses affected by this Section 186, except that the cost limit for structural alterations contained in Section 181(b)(4) shall not be applicable thereto.

(Amended by Ord. 470-79, App. 9/28/79; Ord. 69-87, App. 3/13/87; Ord. 445-87, App. 11/12/87; Ord. 115-90, App. 4/6/90; Ord. 250-06, File No. 061069, App. 10/11/2006; Ord. [63-11](#), File No. 101053, App. 4/7/2011, Eff. 5/7/2011; Ord. [174-12](#), File No. 120715, App. 8/2/2012, Eff. 9/1/2012; Ord. [56-13](#), File No. 130062, App. 3/28/2013, Eff. 4/27/2013; Ord. [235-14](#), File No. 140844, App. 11/26/2014, Eff. 12/26/2014)

AMENDMENT HISTORY

Section header and undesignated introductory paragraph amended; divisions (c) through (e) added; former divisions (c) and (d) redesignated as (f) and [former] (g); Ord. [63-11](#), Eff. 5/7/2011. Divisions (a), (b), (c), (e), and (f) amended; new division (g) added; former division (g) redesignated as (h) and amended; Ord. [174-12](#), Eff. 9/1/2012. Division (a)(1) amended; Ord. [56-13](#), Eff. 4/27/2013. Reference amended in division (c); Ord. [235-14](#), Eff. 12/26/2014.

SEC. 725. UNION STREET NEIGHBORHOOD COMMERCIAL DISTRICT.

The Union Street Commercial District is located in northern San Francisco between the Marina and Pacific Heights neighborhoods. The district lies along Union Street between Van Ness Avenue and Steiner, including an arm extending north on Fillmore Street to Lombard. The shopping area provides limited convenience goods for the residents of sections of the Cow Hollow, Golden Gate Valley, and Pacific Heights neighborhoods immediately surrounding the street. Important aspects of Union Street's business activity are eating and drinking establishments and specialty shops whose clientele comes from a wide trade area. There are also a significant number of professional, realty, and business offices. Many restaurants and bars as well as the district's two movie theaters are open into the evening hours, and on weekends the street's clothing, antique stores and galleries do a vigorous business.

The Union Street District controls are designed to provide sufficient growth opportunities for commercial development that is in keeping with the existing scale and character, promote continuous retail frontage, and protect adjacent residential livability. Small-scale buildings and neighborhood-serving uses are promoted, and rear yards above the ground story and at all residential levels are protected. Most commercial development is permitted at the first two stories of new buildings, while retail service uses are monitored at the third story and above. Controls are necessary to preserve the remaining convenience businesses and to reduce the cumulative impacts which the growth of certain uses have on neighborhood residents. Such controls prohibit additional drinking establishments and limit additional eating establishments, entertainment, and financial service uses. Most automobile and drive-up uses are prohibited in order to maintain continuous retail frontage and minimize further traffic congestion.

Housing development in new buildings is encouraged above the second story. Existing residential units are protected by limitations on demolitions and upper-story conversions.

**Table 725. UNION STREET NEIGHBORHOOD COMMERCIAL DISTRICT
ZONING CONTROL TABLE**

| <i>No.</i> | <i>Zoning Category</i> | <i>§ References</i> | Union Street Controls |
|---------------------------|-------------------------------|--|---|
| BUILDING STANDARDS | | | |
| 725.10 | Height and Bulk Limit | §§ 102.12, 105, 106, 250 - 252, 260, 261.1, 270, 271 | 40-X Height Sculpting on Alleys: § 261.1 |
| 725.11 | Lot Size [Per Development] | §§ 121.1, 790.56 | P up to 4,999 sq. ft. C 5,000 sq. ft. & above § 121.1 |
| | | | Required at the second story and |

| | | | |
|--|---|--|--|
| 725.12 | Rear Yard | §§ 130, 134, 136 | above and at all residential levels § 134(a) (e) |
| 725.13 | Street Frontage | § 145.1 | Required |
| 725.14 | Awning | § 136.1(a) | P |
| 725.15 | Canopy | § 136.1(b) | P |
| 725.16 | Marquee | § 136.1(c) | P |
| 725.17 | Streetscape and Pedestrian Improvements | § 138.1 | Required |
| COMMERCIAL AND INSTITUTIONAL STANDARDS AND USES | | | |
| 725.20 | Floor Area Ratio | §§ 102.9, 102.11, 123 | 3.0 to 1 § 124(a) (b) |
| 725.21 | Use Size [Non-Residential] | § 790.130 | P up to 2,499 sq. ft. C 2,500 sq. ft. & above § 121.2 |
| 725.22 | Off-Street Parking, Commercial/Institutional | §§ 150, 153 - 157, 159 - 160, 204.5 | Generally, none required if occupied floor area is less than 5,000 sq. ft. §§ 151, 161(g) |
| 725.23 | Off-Street Freight Loading | §§ 150, 153 - 155, 204.5 | Generally, none required if gross floor area is less than 10,000 sq. ft. §§ 152, 161(b) |
| 725.24 | Outdoor Activity Area | § 790.70 | P if located in front; C if located elsewhere § 145.2 |
| 725.25 | Drive-Up Facility | § 790.30 | |
| 725.26 | Walk-Up Facility | § 790.140 | P |
| 725.27 | Hours of Operation | § 790.48 | P 6 a.m. - 2 a.m. C 2 a.m. - 6 a.m. |
| 725.30 | General Advertising Sign | §§ 262, 602 - 604, 608, 609 | |
| 725.31 | Business Sign | §§ 262, 602 - 604, 608, 609 | P § 607.1(f) 2 |
| 725.32 | Other Signs | §§ 262, 602 - 604, 608, 609 | P § 607.1(c) (d) (g) |

| No. | Zoning Category | § References | Union Street Controls by Story | | |
|----------------------------------|-----------------|--------------|--------------------------------|-----|------|
| | | | 1st | 2nd | 3rd+ |
| | | § 790.118 | | | |
| Retail Sales and Services | | | | | |

| | | | | | |
|---------|--|---|-----|---|---|
| 725.40 | Other Retail Sales and Services [Not Listed Below] | § 790.102 | P | P | |
| 725.41 | Bar | § 790.22 | | | |
| 725.43 | Limited-Restaurant | § 790.90 | C # | | |
| 725.44 | Restaurant | § 790.91 | C # | | |
| 725.45 | Liquor Store | § 790.55 | C | | |
| 725.46 | Movie Theater | § 790.64 | P | | |
| 725.47 | Adult Entertainment | § 790.36 | | | |
| 725.48 | Other Entertainment | § 790.38 | C | | |
| 725.49 | Financial Service | § 790.110 | P | C | |
| 725.50 | Limited Financial Service | § 790.112 | P | | |
| 725.51 | Medical Service | § 790.114 | P | P | C |
| 725.52 | Personal Service | § 790.116 | P | P | C |
| 725.53 | Business or Professional Service | § 790.108 | P | P | C |
| 725.54 | Massage Establishment | § 790.60, §§ 29.1-29.32 Health Code | | | |
| 725.55 | Tourist Hotel | § 790.46 | C | C | C |
| 725.56 | Automobile Parking | §§ 156, 160, 790.8 | C | C | C |
| 725.57 | Automotive Gas Station | § 790.14 | | | |
| 725.58 | Automotive Service Station | § 790.17 | | | |
| 725.59 | Automotive Repair | § 790.15 | | | |
| 725.60 | Automotive Wash | § 790.18 | | | |
| 725.61 | Automobile Sale or Rental | § 790.12 | | | |
| 725.62 | Animal Hospital | § 790.6 | C | | |
| 725.63 | Ambulance Service | § 790.2 | | | |
| 725.64 | Mortuary | § 790.62 | | | |
| 725.65 | Trade Shop | § 790.124 | P | C | |
| 725.66 | Storage | § 790.117 | | | |
| 725.68 | Fringe Financial Service | § 790.111 | | | |
| 725.69 | Tobacco Paraphernalia Establishments | § 790.123 | C | | |
| 725.69B | Amusement Game Arcade (Mechanical Amusement Devices) | § 790.4 | | | |
| 725.69C | Neighborhood Agriculture | § 102.35(a) | P | P | P |
| 725.69D | Large-Scale Urban Agriculture | § 102.35(b) | C | C | C |

Institutions and Non-Retail Sales and Services

| | | | | | |
|---------------------------------------|--|-------------------------------------|--|---|---|
| 725.70 | Administrative Service | § 790.106 | | | |
| 725.80 | Hospital or Medical Center | § 790.44 | | | |
| 725.81 | Other Institutions, Large | § 790.50 | P | C | C |
| 725.82 | Other Institutions, Small | § 790.51 | P | P | P |
| 725.83 | Public Use | § 790.80 | C | C | C |
| 725.84 | Medical Cannabis Dispensary | § 790.141 | P | | |
| RESIDENTIAL STANDARDS AND USES | | | | | |
| 725.90 | Residential Use | § 790.88 | P | P | P |
| 725.91 | Dwelling Unit Density | § 207 | Generally, up to 1 unit per 600 sq. ft. lot area § 207(c) | | |
| 725.92 | Residential Density, Group Housing | §§ 207, 208 | Generally, up to 1 bedroom per 210 sq. ft. lot area § 208 | | |
| 725.92b | Residential Density, Homeless Shelters | §§ 102, 207.1, 790.88(c) | Density limits per Section 208(a) | | |
| 725.93 | Usable Open Space <i>[Per Residential Unit]</i> | §§ 135, 136 | Generally, either 80 sq. ft if private, or 100 sq. ft. if common § 135(d) | | |
| 725.94 | Off-Street Parking, Residential | §§ 150, 153 - 157, 159 - 160, 204.5 | Generally, 1 space for each dwelling unit §§ 151, 161(a) (g) | | |
| 725.95 | Community Residential Parking | § 790.10 | C | C | C |
| 725.96 | Removal of Residential or Unauthorized Units through Conversion, Demolition, or Merger | § 317 | C | | |

SPECIFIC PROVISIONS FOR THE UNION STREET NEIGHBORHOOD COMMERCIAL DISTRICT

| <u>Article 7 Code Section</u> | <u>Other Code Section</u> | <u>Zoning Controls</u> |
|-------------------------------|---------------------------|---|
| | | UNION STREET RESTAURANTS Boundaries: Applicable to the Union Street Neighborhood Commercial |

| | | |
|----------|----------|---|
| § 725.44 | § 790.91 | <p>District.</p> <p>Applicability: The following controls apply to new uses as well to significant alterations, modifications, and intensifications of existing uses pursuant to § 178(c) of the Planning Code.</p> <p>Controls: The Planning Commission may approve a restaurant if, in addition to meeting the criteria set forth in Section 303, (1) the use is located on the ground floor, and (2) the Planning Commission finds that an additional restaurant would not result in a net total of more than 44 Restaurants in the Union Street Neighborhood Commercial District. The Planning Department shall apply Article 7 zoning controls for Union Street Restaurants to conditional use authorizations required by Planning Code § 178, including but not limited to significant alterations, modifications, and intensifications of use. No new alcoholic beverage license type 47 or 49 shall be permitted in the Union Street NCD. Transfer of an existing license type 47 or 49 from an existing Restaurant located within the Union Street NCD to another Restaurant, new or existing, located within the Union Street NCD is permitted with Conditional Use authorization, consistent with the requirements of Planning Code Section 303.</p> |
| § 725.68 | § 249.35 | <p>FRINGE FINANCIAL SERVICE RESTRICTED USE DISTRICT (FFSRUD)</p> <p>Boundaries: The FFSRUD and its 1/4 mile buffer includes, but is not limited to, the Union Street Neighborhood Commercial District.</p> <p>Controls: Within the FFSRUD and its 1/4 mile buffer, fringe financial services are NP pursuant to Section 249.35. Outside the FFSRUD and its 1/4 mile buffer, fringe financial services are P subject to the restrictions set forth in Subsection 249.35(c)(3).</p> |

(Added by Ord. 69-87, App. 3/13/87; amended by Ord. 445-87, App. 11/12/87; Ord. 412-88, App. 9/10/88; Ord. 87-00, File No. 991963, App. 5/19/2000; Ord. 260-00, File No. 001424, App. 11/17/2000; Ord. 275-05, File No. 051250, App. 11/30/2005; Ord. 289-06, File No. 050176, App. 11/20/2006; Ord. 269-07, File No. 070671, App. 11/26/2007; Ord. 244-08, File No. 080567, App. 10/30/2008; Ord. 245-08, File No. 080696; Ord. 8-09, File No. 080872, App. 1/16/2009; Ord. 51-09, File No. 081620, App. 4/2/2009; Ord. 98-09, File No. 090274, App. 6/19/2009; Ord. 66-11, File No. 101537, App. 4/20/2011, Eff. 5/20/2011; Ord. 140-11, File No. 110482, App. 7/5/2011, Eff. 8/4/2011; Ord. 75-12, File No. 120084, App. 4/23/2012, Eff. 5/23/2012; Ord. 214-12, File No. 120773, App. 10/9/2012, Eff. 11/8/2012; Ord. 56-13, File No. 130062, App. 3/28/2013, Eff. 4/27/2013; Ord. 287-13, File No. 130041, App. 12/26/2013, Eff. 1/25/2014; Ord. 235-14, File No. 140844, App. 11/26/2014, Eff. 12/26/2014; Ord. 14-15, File No. 141210, App. 2/13/2015, Eff. 3/15/2015; Ord. 20-15, File No. 110548, App. 2/20/2015, Eff. 3/22/2015; redesignated and amended by Ord. 30-15, File No. 140954, App. 3/26/2015, Eff. 4/25/2015; amended by Ord. 33-16, File No. 160115, App. 3/11/2016, Eff. 4/10/2016)

AMENDMENT HISTORY

Zoning Control Table: 725.69C and 725.69D added; Ord. 66-11, Eff. 5/20/2011. Zoning Control Table: 725.10, 725.17, and 725.42 amended; Specific Provisions: 725.68 added; Ord. 140-11, Eff. 8/4/2011. Zoning Control Table: 725.43 and 725.44 amended, former categories 725.42, 725.67, and 725.69A deleted; Specific Provisions: 725.44 amended, 725.44, 725.69B deleted; Ord. 75-12, Eff. 5/23/2012. Zoning Control Table: 725.43 and 725.69B amended; Specific Provisions: 725.44 amended; Ord. 214-12, Eff. 11/8/2012. Zoning Control Table: 725.13 and 725.69B amended; Specific Provisions: 725.44 amended; Ord. 56-13, Eff. 4/27/2013. Zoning Control Table: former categories 725.38 and 725.39 redesignated as 725.36 and 725.37 and amended; Ord. 287-13, Eff. 1/25/2014. Zoning Control Table: 725.26 and 725.49 amended; Ord. 235-14, Eff. 12/26/2014. Zoning Control Table: 725.92b added; Ord. 14-15, Eff. 3/15/2015.

Zoning Control Table: 725.14, 725.15, 725.16, and 725.17 amended; Ord. [20-15](#), Eff. 3/22/2015. Section redesignated (formerly Sec. 725.1); Zoning Control Table: 725.54, 725.91, and 725.92 amended; Ord. [30-15](#), Eff. 4/25/2015. Zoning Control Table: former categories 725.36 and 725.37 deleted, 725.96 added; Ord. [33-16](#), Eff. 4/10/2016.



SAN FRANCISCO PLANNING DEPARTMENT

Report for: 1800 FILBERT



Property Report: 1800 FILBERT

General information related to properties at this location.

PARCELS (Block/Lot):

0519/053-054 (2 lots)

PARCEL HISTORY:

0519/052 became 0519/053 on 11/25/2003 2:24:00 PM

0519/052 became 0519/054 on 11/25/2003 2:24:00 PM

0519/008 became 0519/052 on 4/3/2003 9:28:00 AM

0519/008 became 0519/052 on 4/3/2003 9:28:00 AM

ADDRESSES:

1800 FILBERT ST, SAN FRANCISCO, CA 94123 (parcel 0519/053)

1804 FILBERT ST, SAN FRANCISCO, CA 94123 (parcel 0519/054)

NEIGHBORHOOD:

Marina

CURRENT PLANNING TEAM:

NW Team

PLANNING DISTRICT:

District 2: Marina

SUPERVISOR DISTRICT:

District 2 (Mark Farrell)

CENSUS TRACTS:

2010 Census Tract 012902

TRAFFIC ANALYSIS ZONE:

Traffic Analysis Zone: 370

RECOMMENDED PLANTS:

Would you like to grow plants that create habitat and save water? Check out the plants that we would recommend for this property at [SF Plant Finder](#).

CITY PROPERTIES:

None

PORT FACILITIES:

None

ASSESSOR'S REPORT:

Address: 1800 FILBERT ST
Parcel: 0519053
Assessed Values:
Land: \$574,208.00
Structure: \$574,208.00
Fixtures: -
Personal Property: -
Last Sale: 6/9/2006
Last Sale Price: \$1,010,000.00
Year Built: 1900
Building Area: 1,952 sq ft
Parcel Area: -
Parcel Shape: -
Parcel Frontage: -
Parcel Depth: -
Construction Type: -
Use Type: Commercial Store Condo
Units: 1
Stories: 1
Rooms: -
Bedrooms: -
Bathrooms: 1
Basement: -

Address: 1804 FILBERT ST
Parcel: 0519054
Assessed Values:
Land: \$574,217.00
Structure: \$574,217.00
Fixtures: -
Personal Property: -
Last Sale: 6/9/2006
Last Sale Price: \$1,010,000.00
Year Built: 1900
Building Area: 1,738 sq ft
Parcel Area: -
Parcel Shape: -
Parcel Frontage: -
Parcel Depth: -

Construction Type: -
Use Type: Condominium
Units: -
Stories: 1
Rooms: 5
Bedrooms: -
Bathrooms: 1
Basement: -

Zoning Report: 1800 FILBERT

Planning Department Zoning and other regulations.

ZONING DISTRICTS:

RH-2 - RESIDENTIAL-HOUSE, TWO FAMILY

HEIGHT & BULK DISTRICTS:

40-X

SPECIAL USE DISTRICTS:

None

SPECIAL SIGN DISTRICTS:

None

LEGISLATIVE SETBACKS:

None

COASTAL ZONE:

Not in the Coastal Zone

PORT:

Not under Port Jurisdiction

LIMITED AND NONCONFORMING USES:

None

NEIGHBORHOOD-SPECIFIC IMPACT FEE AREAS:

In addition to those impact fees that apply throughout the City, the following neighborhood-specific impact fees apply to this particular property:

None

An overview of Development Impact Fees can be found on the [Impact Fees](#) website.

REDEVELOPMENT AREAS:

None

OTHER INFORMATION:

PLANNING AREAS:

None

MAYOR'S INVEST IN NEIGHBORHOODS INITIATIVE AREA:

None

COMMUNITY BENEFIT DISTRICT:

None

SCHOOLS:

Within 1,000ft of: Sherman Elementary School

NOTICE OF SPECIAL RESTRICTIONS:

NSR No.: H083097

Restriction: Minor modifications as determined by the ZA may be permitted if it is demonstrated that such modifications are necessary in order to comply with DBI requirements.

Permit No:

NSR Date: 1/3/2002

NSR No.: H251033

Restriction: Minor modifications as determined by the ZA may be permitted if it is demonstrated that such modifications are necessary in order to comply with DBI requirements.

Permit No:

NSR Date: 9/24/2002

ZONING LETTERS OF DETERMINATION:

Historic Preservation Report: 1800 FILBERT

Historic preservation surveys and evaluations. The Historic Resource status shown on this page is tentative, to confirm the status of your property please speak to a Preservation Technical Specialist. Tel: 415-558-6377; Email: pic@sfgov.org

HISTORIC EVALUATION:

Parcel: 0519053
Building Name:
Address: 1800 FILBERT ST
Planning Dept. Historic Resource Status: B - Unknown / Age Eligible

ARTICLE 10 DESIGNATED HISTORIC DISTRICTS AND LANDMARKS:

None

ARTICLE 11 PRESERVATION DESIGNATION:

None

NATIONAL REGISTER HISTORIC DISTRICTS:

None

CALIFORNIA REGISTER HISTORIC DISTRICTS:

None

HISTORIC RESOURCE EVALUATION RESPONSES:

None

HISTORIC SURVEYS:

None

HISTORIC CONTEXT STATEMENTS:

None

ARCHITECTURE:

Unknown

Planning Applications Report: 1800 FILBERT

Permits are required in San Francisco to operate a businesses or to perform construction activity. The Planning Department reviews most applications for these permits in order to ensure that the projects comply with the [Planning Code](#). The 'Project' is the activity being proposed.

PLANNING APPLICATIONS:

2002.0751Q

[C.JAROSLA](#) Tel: 558-6377

Condo-REF (CND) 1800 Filbert Street/2907 Octavia St

2 UNIT CONDO CONVERSION

| OPENED | STATUS | ADDRESS | FURTHER INFO |
|-----------|--------------------------------|---|----------------------|
| 6/17/2002 | Closed - Approved 7/24/2002 | 1800 FILBERT ST, SAN FRANCISCO, CA 94123 | View |

RELATED RECORDS: [2002.0751](#)
- [2002.0751Q](#)

2002.0751

[Planning Information Center](#) Tel: 558-6377

Project Profile (PRJ) 1800 Filbert Street/2907 Octavia St

2 UNIT CONDO CONVERSION

| OPENED | STATUS | ADDRESS | FURTHER INFO |
|-----------|--------|---|----------------------|
| 6/17/2002 | Closed | 1800 FILBERT ST, SAN FRANCISCO, CA 94123 | View |

RELATED RECORDS: [2002.0751](#)
- [2002.0751Q](#) **RELATED BUILDING PERMITS:** None

2002.0561

[Planning Information Center](#) Tel: 558-6377

Project Profile (PRJ) 2907 OCTAVIA ST

2 LOT SUBDIVISION

| OPENED | STATUS | ADDRESS | FURTHER INFO |
|-----------|--------|---|----------------------|
| 4/17/2002 | Closed | 1800 FILBERT ST, SAN FRANCISCO, CA 94123 | View |

RELATED RECORDS: [2002.0561](#)
- [2002.0561S](#) **RELATED BUILDING PERMITS:** None

2002.0561S

[C.JAROSLA](#) Tel: 558-6377

Subdivision-REF (SUB) 2907 OCTAVIA ST

2 LOT SUBDIVISION

| OPENED | STATUS | ADDRESS | FURTHER INFO |
|-----------|--------------------------------|---|----------------------|
| 4/17/2002 | Closed - Approved 5/16/2002 | 1800 FILBERT ST, SAN FRANCISCO, CA 94123 | View |

RELATED RECORDS: [2002.0561](#)
- [2002.0561S](#)

2001.0928 [Planning Information Center](#) Tel: 558-6377

Project Profile (PRJ) 1800 Filbert Street/2907 Octavia St

Sub division to create one complying lot and one lot which is under the required lot size. Variance required to create the proposed lot.

| OPENED | STATUS | ADDRESS | FURTHER INFO |
|-----------|--------|---|----------------------|
| 9/25/2001 | Closed | 1800 FILBERT ST, SAN FRANCISCO, CA 94123 | View |

RELATED RECORDS: [2001.0928](#)
- [2001.0928V](#) RELATED BUILDING PERMITS: None

2001.0928V [VMASSEHI](#) Tel: 558-6377

Variance (VAR) 1800 Filbert Street/2907 Octavia St

Sub division to create one complying lot and one lot which is under the required lot size. Variance required to create the proposed lot.

| OPENED | STATUS | ADDRESS | FURTHER INFO |
|-----------|---------------------------------|---|----------------------|
| 9/25/2001 | Closed - Approved 11/14/2001 | 1800 FILBERT ST, SAN FRANCISCO, CA 94123 | View |

RELATED RECORDS: [2001.0928](#)
- [2001.0928V](#)

762PRV [Mary Cheung-Woods](#) Tel: 415-558-6315

Project Review Meetings (PRV) Project Review Meeting with Robert Meyers (Mary Woods) - Wednesday, June 13, 2001

Project Review Meeting with Robert Meyers (Mary Woods) - Wednesday, June 13, 2001

| OPENED | STATUS | ADDRESS | FURTHER INFO |
|-----------|-------------------------------------|---|----------------------|
| 6/11/2001 | Closed - Informational 6/13/2001 | 1800 FILBERT ST, SAN FRANCISCO, CA 94123 | View |

RELATED RECORDS: None

SHORT TERM RENTALS:

None

Building Permits Report: 1800 FILBERT

Applications for Building Permits submitted to the Department of Building Inspection.

BUILDING PERMITS:

Permit: 9921723
Form: 8 - Alterations Without Plans
Filed: 10/13/1999
Address: 1800 FILBERT ST
Existing: OFFICE
Proposed: OFFICE
Existing Units: 1
Proposed Units: 2
Status: EXPIRED
Status Date: 2/13/2000
Description: REVISION TO APPL 9918936, DEMO 9918936
Cost: \$1,000.00

Permit: 200607186935
Form: 8 - Alterations Without Plans
Filed: 7/18/2006
Address: 1800 FILBERT ST
Parcel: 0519/053
Existing: OFFICE
Proposed: OFFICE
Existing Units: 1
Proposed Units: 1
Status: COMPLETE
Status Date: 10/27/2006
Description: INSTALL STEEL MOMENT FRAME AT SOUTH WALL 1ST FL LEVEL, UPGRADE EXIST CONCRETE FOUNDATION (SOUTH WALL) REENFORCE (E) BEAM & POST CONNECTIONS IN BSMT W/ STEEL PLATE CONNECTORS. VOLUNTARY SEISMIC STRENGTHENING (N) MOMENT FRAME DOES NOT CARRY GRAVITY LOAD.THEREFORE 1 HR FIRE PROTECTION NOT REQ.
Cost: \$27,000.00

Permit: 200305084082
Form: 8 - Alterations Without Plans
Filed: 5/8/2003
Address: 2907 OCTAVIA ST
Parcel: 0519/008
Existing: 2 FAMILY DWELLING
Proposed: 2 FAMILY DWELLING
Existing Units: 2

Proposed Units: 2
Status: COMPLETE
Status Date: 7/14/2003
Description: REMODEL LIVING ROOM AND BEDROOM. REMOVE INTERIOR COVERING OF EXTERIOR WALLS AND CEILING OF LIVING RO
Cost: \$5,000.00

Permit: 200304172505
Form: 8 - Alterations Without Plans
Filed: 4/17/2003
Address: 2907 OCTAVIA ST
Parcel: 0519/008
Existing: 2 FAMILY DWELLING
Proposed: 2 FAMILY DWELLING
Existing Units: 2
Proposed Units: 2
Status: COMPLETE
Status Date: 7/14/2003
Description: REMODELING KITCHEN & BATHROOM
Cost: \$8,000.00

Permit: 200303038612
Form: 8 - Alterations Without Plans
Filed: 3/3/2003
Address: 1800 FILBERT ST
Parcel: 0519/008
Existing: OFFICE
Proposed: OFFICE
Existing Units: 1
Proposed Units: 1
Status: COMPLETE
Status Date: 3/11/2003
Description: SUPPLEMENT TO BUILDING PERMIT 200210158998 TO CONSTRUCT 42" HIGH 1 HR RATED WALL AROUND EXISTING
Cost: \$400.00

Permit: 200210158998
Form: 3 - Alterations With Plans
Filed: 10/15/2002
Address: 1804 FILBERT ST
Parcel: 0519/008
Existing: 1 FAMILY DWELLING
Proposed: 1 FAMILY DWELLING
Existing Units: 1
Proposed Units: 1

Status: COMPLETE
Status Date: 12/23/2002
Description: COMPLY W/3R-371,CORRECT THE REPORT OF RESIDENTIAL BLDG RECORD TO INDICATE 2 STRUCTURES
Cost: \$15,000.00

Permit: 200210158998
Form: 3 - Alterations With Plans
Filed: 10/15/2002
Address: 1800 FILBERT ST
Parcel: 0519/008
Existing: 1 FAMILY DWELLING
Proposed: 1 FAMILY DWELLING
Existing Units: 1
Proposed Units: 1

Status: COMPLETE
Status Date: 12/23/2002
Description: COMPLY W/3R-371,CORRECT THE REPORT OF RESIDENTIAL BLDG RECORD TO INDICATE 2 STRUCTURES
Cost: \$15,000.00

Permit: 200208204405
Form: 8 - Alterations Without Plans
Filed: 8/20/2002 9:42:24 AM
Address: 2907 OCTAVIA ST
Parcel: 0519/008
Existing: 2 FAMILY DWELLING
Proposed: 2 FAMILY DWELLING
Existing Units: 2
Proposed Units: 2

Status: COMPLETE
Status Date: 12/23/2002
Description: REPAIR DRYROT AT SOUTH SIDE MUDSILL AT DRIVEWAY, PATCH SIDING.
Cost: \$1,500.00

Permit: 200208204405
Form: 8 - Alterations Without Plans
Filed: 8/20/2002 9:42:24 AM
Address: 2909 OCTAVIA ST
Parcel: 0519/008
Existing: 2 FAMILY DWELLING
Proposed: 2 FAMILY DWELLING
Existing Units: 2
Proposed Units: 2
Status: COMPLETE

Status Date: 12/23/2002
Description: REPAIR DRYROT AT SOUTH SIDE MUDSILL AT DRIVEWAY, PATCH SIDING.

Cost: \$1,500.00

Permit: 20003073613

Form: 8 - Alterations Without Plans

Filed: 3/7/2000 9:32:19 AM

Address: 1800 FILBERT ST

Parcel: 0519/008

Existing: OFFICE

Proposed: OFFICE

Existing Units: 0

Proposed Units: 0

Status: COMPLETE

Status Date: 3/28/2000

Description: rev. to pa#9918936-rev. from steel post to wood post

Cost: \$1.00

Permit: 9926834

Form: 8 - Alterations Without Plans

Filed: 12/22/1999

Address: 1800 FILBERT ST

Existing: OFFICE

Proposed: OFFICE

Existing Units: 1

Proposed Units: 1

Status: EXPIRED

Status Date: 4/22/2000

Description: REVISION TO APP #9918936

Cost: \$1.00

Permit: 9918936

Form: 3 - Alterations With Plans

Filed: 9/9/1999

Address: 1800 FILBERT ST

Existing: OFFICE

Proposed: OFFICE

Existing Units: 1

Proposed Units: 1

Status: COMPLETE

Status Date: 3/15/2000

Description: RENOVATION OF OFFICE SPACE WITH UPDATED HANDICAP FACILITIES

Cost: \$35,000.00

Permit: **9918574**
Form: 8 - Alterations Without Plans
Filed: 9/3/1999
Address: 1800 FILBERT ST
Existing: OFFICE
Proposed: OFFICE
Existing Units: 1
Proposed Units: 1
Status: EXPIRED
Status Date: 1/3/2000
Description: INTERIOR NON STRUCTURAL DEMO ONLY
Cost: \$2,000.00

Miscellaneous Permits Report: 1800 FILBERT

Depending on the activity being proposed a permit may need to be obtained from the Fire Department, Health Department, Police Department, Alcoholic Beverage Commission or other organization. The Planning Department reviews most applications for these permits in order to ensure compliance with the Planning Code.

MISCELLANEOUS PERMITS REVIEWED BY THE PLANNING DEPT:

None

Complaints Report: 1800 FILBERT

The Planning Department and the Department of Building Inspection operate programs that ensure compliance with the San Francisco Planning Code and Building Inspection Commission Codes respectively. Additionally, they respond to customer complaints of potential code violations and initiate fair and unbiased enforcement action to correct those violations and educate property owners to maintain code compliance.

COMPLAINTS - PLANNING DEPT:

None

Appeals Report: 1800 FILBERT

Planning Projects, Building Permits and Zoning Determinations appealed to the San Francisco Board of Appeals.

APPEALS:

None

Block Book Notifications Report: 1800 FILBERT

A Block Book Notification (BBN) is a request made by a member of the public to be notified of permits on any property that is subject to the San Francisco Planning Code.

You can also sign up to be emailed when new planning applications or building permits are filed in your neighborhood through our Permits in Your Neighborhood website.

BLOCK BOOK NOTIFICATIONS:

None

The Disclaimer: The City and County of San Francisco (CCSF) does not guarantee the accuracy, adequacy, completeness or usefulness of any information. CCSF provides this information on an 'as is' basis without warranty of any kind, including but not limited to warranties of merchantability or fitness for a particular purpose, and assumes no responsibility for anyone's use of the information.

Printed: 6/21/2016

<http://propertymap.sfplanning.org>



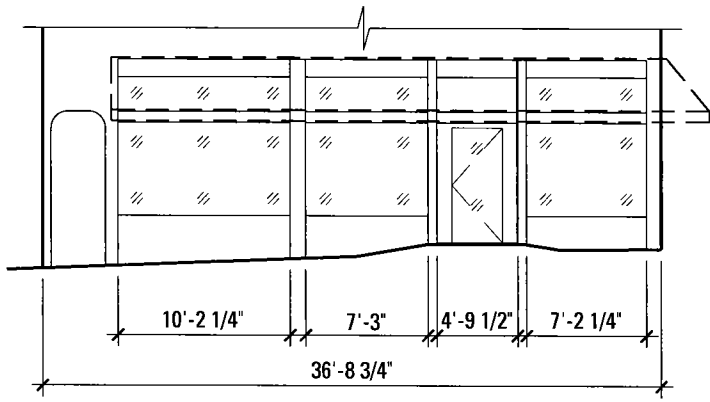

FILBERT STREET ELEVATION

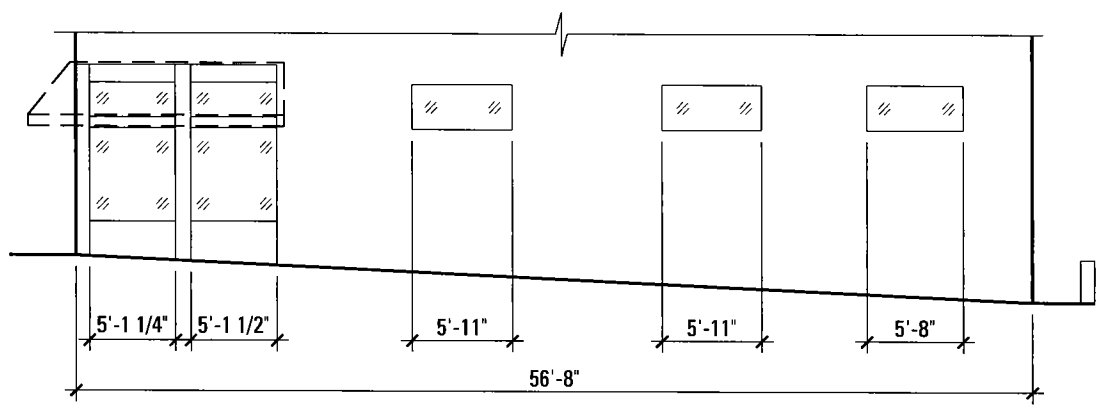

OCTAVIA STREET ELEVATION

PERCENTAGE OF WINDOW AREA CALCULATION

TOTAL WINDOW WIDTH (BOTH FRONTAGES): 57'-1 3/4" (57.15 LINEAR FEET)
 TOTAL STREET FRONTAGE LENGTH: 93'-4 3/4" (93.40 LINEAR FEET)
 PERCENTAGE OF WINDOW AREA: 61.2 %

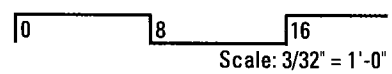

EXISTING ELEVATIONS

LOD

1800 FILBERT STREET | SAN FRANCISCO, CA

27 APRIL 2016



101 Montgomery Street, Suite 650
 San Francisco, CA 94104
 T 415 346 9990
 martinkovicmilford.com